

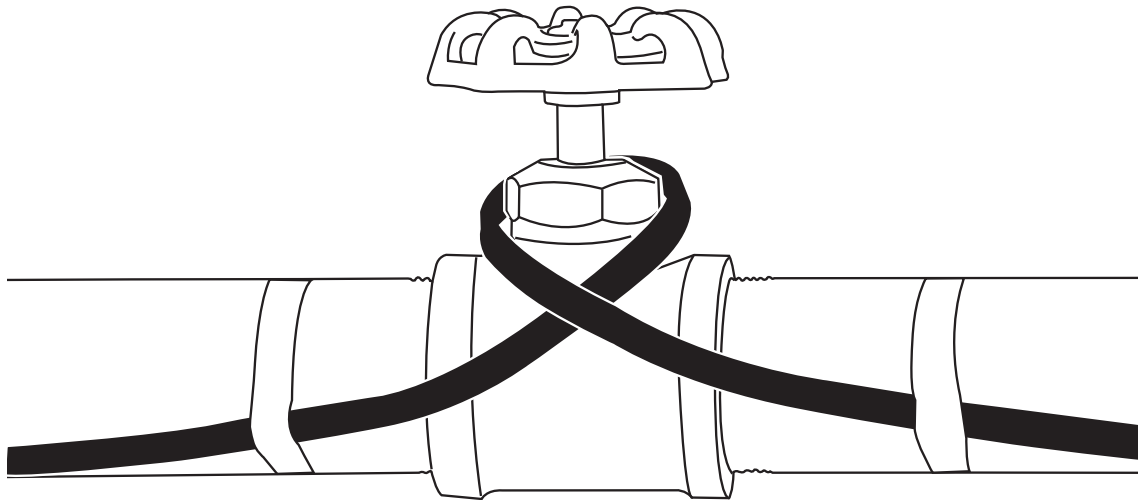

**WarmlyYours**  
Radiant Heating

# **PRO-Tect Pipe Freeze Protection Self-Regulating Heating Cable Install Manual (PT-Series)**



## ***Assembly Tools Needed***

- Utility knife
- Wire cutter
- Needle-nose pliers
- Adjustable wrench
- Pen
- Screwdriver
- Heat gun
- Measuring tape

## ***Other Materials Required***

- Certified junction box appropriate for the site (Power Connection Kit available on our website)
- Aluminum tape (Available on our website)
- Fiberglass tape (Available on our website)
- Pipe Straps
- Plastic Zip Ties
- Megohmmeter (500 VDC)

## ***General Safety Information***

Read and understand all instructions in this manual, including all installation instructions and safety warnings, before beginning the installation. Electrical cables can present a fire, shock, and arcing hazard if they are damaged or not installed correctly.

1. Installation must be in compliance with the National Electrical Code (NEC).
2. Use 30-mA ground-fault protection on each heating cable branch circuit for maximum protection.
3. The black heating cable core is conductive and can short. It must be properly insulated and kept dry.
4. The braided ground sheath of the heating cable must have a suitable grounding terminal.
5. Installer should apply the nameplate label to surface of the junction box.
6. Keep components and ends of heating cable dry before installation.
7. Do not break braid or bus wire strands when scoring the jacket or core. Damaged bus wires can overheat or short.
8. Keep the bus wires separated. The bus wires will short if they touch each other.
9. Replace damaged parts. Heat-damaged components can short.
10. Use heat gun or torch with a soft yellow, low-heat flame--not a blue flame. Keep the flame moving to prevent overheating or blistering the heat-shrinkable tubes.
11. Do not heat other components.
12. Use only fire-resistant insulation materials such as fiberglass wrap (If outdoors, make sure to waterproof all insulated piping).
13. De-energize all circuits before installation or service.
14. The heating cable should not be embedded in insulation or roofing material.
15. Do not twist cable during installation.
16. Save all instructions for future reference.
17. Don't install until after all piping has passed proper pressure testing.

*CAUTION: Charring or burning the heat-shrinkable tubes in this kit will produce fumes that may cause eye, skin, nose, and throat irritation.*



**A**



**B**



**C**



**D**



**E**



**F**

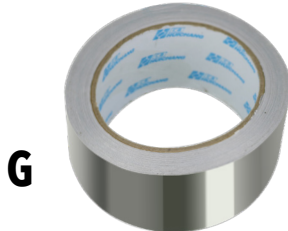

**G**



**H**

Item	Part#	Description
A	PT-Series	PRO-Tect Pipe Freeze Protection Self-Regulating Heating Cable
B	PT-END-KIT-H	End Seal Termination Kit
C	PT-PWR-KIT-H	Power Connection Kit (Includes Junction Box)
D	PT-SPLICE-L-H	In-Line Splice Kit
E	PT-SPLICE-T-H	T-Splice Kit
F	PT-LABEL-RED	Red Warning Label
G	PT-TAPE-AL	Aluminum Tape (98 feet x 2 inches)
H	PT-TAPE-FG	Fiberglass Tape (66 feet x 0.5 inches)

## Pipe Freeze Protection

### HEATING CABLE SELECTION (PT-SERIES)

**Table 1.** PT-Series self-regulating heating cable for METAL pipes with fiberglass insulation or equivalent (based on 40°F constant temperature with a 10% safety factor)

#### Nominal Metal Pipe Sizes

Lowest Air Temp.	Insulation	1/2"	3/4"	1"	1 1/4"	1 1/2"	2"	2 1/2"	3"	4"	6"	8"	10"
0° F	1/2"	3 W/ft	3 W/ft	3 W/ft	3 W/ft	5 W/ft	5 W/ft	5 W/ft	5 W/ft	5 W/ft	8 W/ft	8 W/ft	10 W/ft
	1"	3	3	3	3	3	3	3	3	5	5	8	8
	1 1/2"	3	3	3	3	3	3	3	3	5	5	5	5
-20° F	1/2"	3	5	5	5	5	5	5	5	8	8	10	20
	1"	3	3	3	3	3	5	5	5	5	8	8	10
	1 1/2"	3	3	3	3	3	3	3	5	5	5	5	8
	2"	3	3	3	3	3	3	3	3	3	5	5	8
-40° F	1/2"	5	5	5	5	5	5	8	8	8	10	10	22
	1"	3	3	3	5	5	5	5	5	5	5	8	14
	1 1/2"	3	3	3	3	3	5	5	5	5	5	5	10
	2"	3	3	3	3	3	3	3	5	5	5	5	8

**Table 2.** Pt-Series self-regulating heating cable for PLASTIC pipes with fiberglass insulation or equivalent (based on 40°F constant temperature with a 10% safety factor).

#### Nominal Plastic Pipe Sizes

Lowest Air Temp.	Insulation	1/2"	3/4"	1"	1 1/4"	1 1/2"	2"	2 1/2"	3"	4"	6"	8"	10"
0° F	1/2"	5 W/ft	5 W/ft	5 W/ft	5 W/ft	5 W/ft	5 W/ft	5 W/ft	8 W/ft	8 W/ft	10 W/ft	10 W/ft	12 W/ft
	1"	3	5	5	5	5	5	5	5	5	8	8	10
	1 1/2"	3	3	3	5	5	5	5	5	5	5	5	8
-20° F	1/2"	5	5	5	5	5	5	8	8	10	10	12	24
	1"	5	5	5	5	5	5	5	8	8	10	10	12
	1 1/2"	5	5	5	5	5	5	5	5	8	8	10	12
	2"	3	5	5	5	5	5	5	5	3	8	8	10
-40° F	1/2"	8	8	8	8	8	10	10	12	12	12	12	24
	1"	5	5	5	8	8	8	8	10	10	12	12	14
	1 1/2"	5	5	5	5	5	5	5	8	8	10	10	12
	2"	5	5	5	5	5	5	5	8	8	8	10	12

NOTE: For piping 12" in diameter or larger, WarmlyYours requires multiple passes of heat tracing. To seek assistance from a WarmlyYours representative, call us at (800) 875-5285.

## Pipe Freeze Protection (continued)

### ATTACHING HEATING CABLE TO PIPE

1. Prior to installing the cable, be sure all piping is dry and any sharp surfaces are removed.
2. The cable must be installed 10 inches away from combustible surfaces, such as wood.
3. The minimum bending radius of each flexible heating device is 1/2 inch.
4. Cut the cable to length needed. Do this before or after the cable is attached to the pipe (follow "Maximum Length vs. Circuit Breaker Size" circuit guidelines provided on page 5).
5. Provide for a minimum of 1' of extra heating cable to connect to power source or for splices.
6. Do not attach the cable to the pipe in a spiral pattern. Attach the cable in straight runs according to the directions in Step 7 below.
7. If the heating cable is the same length as the pipe, run it straight along at the 8 o'clock position of the pipe. If two cables are required, position them in the 4 and 8 o'clock positions.

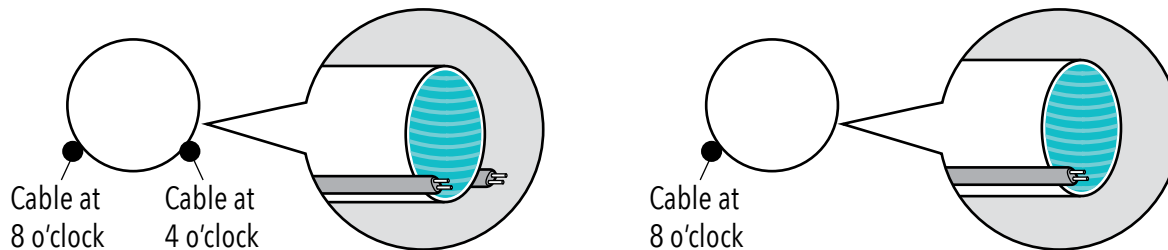

8. Any excess cable remaining at the end of the pipe can be doubled back along the pipe.
9. Be sure to include additional heating cable required for valves, spigots, elbows unions, supports, hangers, cleanouts, etc.
10. Secure the cable to the pipe with fiberglass application tape and aluminum tape. DO NOT use vinyl tape or wire.
11. Install all end seals and power connection before turning on power.
12. If the heating cable ends will be left exposed before connection, be sure to protect them from moisture or mechanical damage.

### INSTALL THERMAL INSULATION

1. Before installing the insulation, inspect the cable to ensure that it is free of mechanical damage, such as gouges or cuts.
2. Cover the pipe, cables, connections, and valves with fiberglass insulation or better. DO NOT leave the cables exposed. The proper thickness can be determined by calling a WarmlyYours representative at (800) 875-5285.
3. Use fire-resistant materials such as fiberglass wrap. Make sure the insulation is waterproofed (with polyethylene or other vapor barriers) in areas where water may come in contact with the insulation (for all outdoor applications).
4. Place the warning labels every 10 feet, on the outer surface of the pipe insulation at suitable locations and where they will be clearly visible to indicate the presence of electric heating cable.

### MAINTENANCE CHECKS

1. Only qualified persons should service or install the system.
2. Inspect the system annually. Check for any damage to the heating cable. Check any ground fault protection device for proper operation. If any damage to cable is found, DO NOT operate until it is replaced.
3. Use a 2500Vdc megohmmeter (500Vdc minimum) to test the insulation resistance between the bus wire and the heater ground wire or pipe. The reading should be at least 20 megohms (regardless of cable length).

**Table 3.** Maximum PT-Series Heating Cable Circuit Length for Pipe Freeze Protection.

**Maximum Length vs. Circuit Breaker Size**

Minimum Start-up Temperature	Breaker size	5 Watts per Foot				8 Watts per Foot				10 Watts per Foot			
		Amps	120V	208V	240V	277V	120V	208V	240V	277V	120V	208V	240V
0°F (-18°C)	15	140	268	285	311	100	184	200	222	80	147	160	178
	20	190	357	380	414	130	244	265	294	110	198	215	239
	30	270	508	540	589	200	368	400	444	160	299	325	361
	40	270	508	540	589	210	386	420	466	180	331	360	400
-20°F (-29°C)	15	125	235	250	273	85	161	175	194	70	133	145	161
	20	165	310	330	360	115	216	235	261	95	175	190	211
	30	250	470	500	545	175	322	350	389	145	262	285	316
	40	270	508	540	589	210	386	420	466	180	331	360	400
-40°F (-40°C)	15	110	207	220	240	80	143	155	172	60	115	125	139
	20	145	277	295	322	105	193	210	233	85	156	170	189
	30	220	414	440	480	155	290	315	350	125	235	255	283
	40	270	508	540	589	210	386	420	466	170	313	340	377

# PT-END-KIT-H (JHE-GET)

## INSTALLATION INSTRUCTIONS

### Description

The JHE-GET is design to be use with parallel heating cables.  
 The JHE-GET is installed on pipe under insulation and/or cladding.  
 The JHE-GET is a (RATED NEMA TYPE 4X)

### Tools & Material Needed

- Wire cutter
- Nose Pliers
- Screwdriver
- Tie Wrap
- Glass Cloth Tape
- JSR03

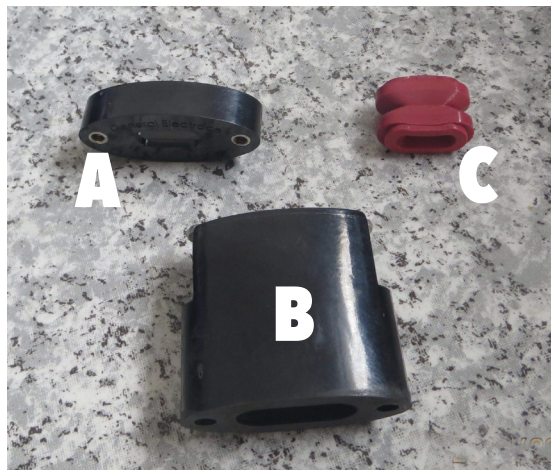

### Kit includes

Item	Qty	Description
A	1	Seal plate for Main Box
B	1	Main End Seal Box
C	1	Red Grommets
D	1	Label



C US

Class I, Div. 2, Groups A, B, C, D<sup>(2)</sup>  
 Class II, Div. 2, Groups E, F, G121  
 Class III<sup>(2)</sup>

### WARNING

This component is an electrical device that must be installed correctly to ensure proper operation and to prevent shock or fire. Read these important warnings and carefully follow all of the installation instructions.

- To minimize the danger of fire from sustained electrical arcing if the heating cable is damaged or improperly installed, and to comply with certifications, and National Electrical Codes, groundfault equipment protection must be used. Arcing may not be stopped by conventional circuit breakers.
- Component approvals and performance are based on the use of specified parts only. Do not use substitute parts or vinyl electrical tape.

- The black heating cable core is conductive and can short. It must be properly insulated and kept dry.
- Damaged bus wires can overheat or short. Do not break bus wire strands when scoring the jacket or core.
- Keep components and heating cable ends dry before and during installation.
- Bus wires will short if they contact each other. Keep bus wires separated.
- Use only fire-resistant insulation materials, such as fiberglass wrap or flame-retardant foam.

## Description

Cable description

Heating Cable	Type	Grommet
HTR	-CR or -CT	RED

WARNING: Use of the wrong grommet can result in leaks, cracked components, shock or dielectric failure, and will invalidate approvals and certifications

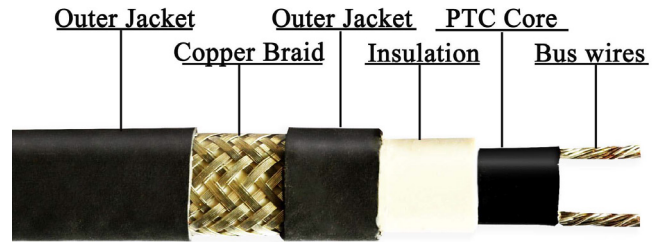

Structure of Model HTR-CR

### STEP 1

Insert first the Pressure Seal End then the Grommet into the cable.

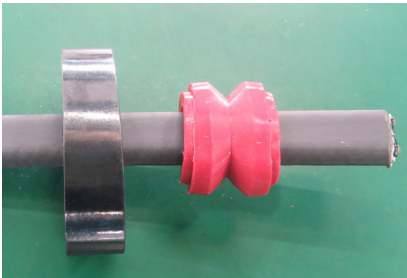

### STEP 2

- Do not cut the braiding
- Denude outer jacket
- Slightly bend the cable where you made the cut to denude it.

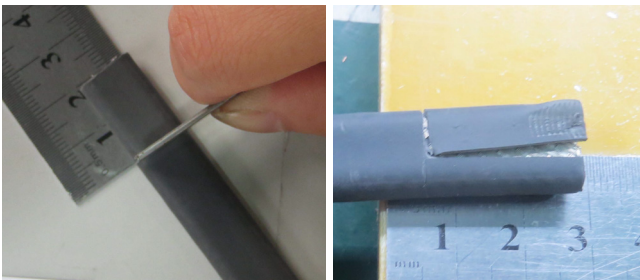

### STEP 3

- Remove excess braiding

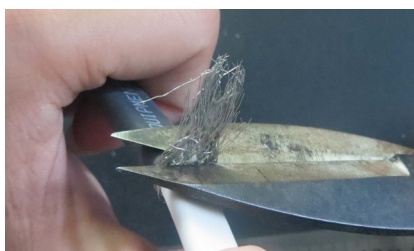

### STEP 4

- Insert the heating cable into the main box
- Install the grommet into position
- Screw the Pressure Seal End into the main box



### STEP 5

- Fix the Low Profile End Seal Box and side wires to the pipe with tape
- Install insulation
- Install label on the of the insulation protector
- Give instruction to the owner/user.





# PT-SPLICE-L-H (JHS-GET)

## INSTALLATION INSTRUCTIONS

### Description

The JHS-GET is design to be use with (HTR) parallel heating cables. The JHS-GET is installed on pipe under insulation and/or cladding. The JHS-GET is a (RATED NEMA TYPE 4X)

### Tools & Material Needed

- Wire cutter
- Nose Pliers
- Screwdriver
- Tie Wrap
- Glass Cloth Tape
- JSR03

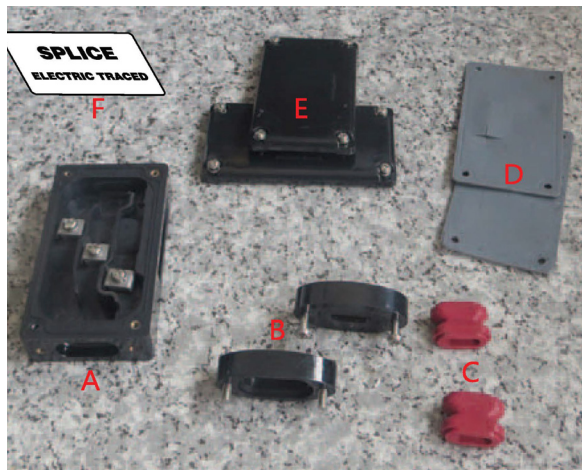

### Kit includes

Item	Qty	Description
A	1	Main Box
B	2	Pressure Seal End
C	2	Red Grommets
D	2	Gaskets for Main Box
E	2	Cover for Main Box
F	1	Label



C US

Class I, Div. 2, Groups A, B, C, D<sup>(2)</sup>  
 Class II, Div. 2, Groups E, F, G121  
 Class III<sup>(2)</sup>

### WARNING

This component is an electrical device that must be installed correctly to ensure proper operation and to prevent shock or fire. Read these important warnings and carefully follow all of the installation instructions.

- To minimize the danger of fire from sustained electrical arcing if the heating cable is damaged or improperly installed, and to comply with the requirements certifications, and National Electrical Codes, groundfault equipment protection must be used. Arcing may not be stopped by conventional circuit breakers.
- Component approvals and performance are based on the use of specified parts only. Do not use substitute parts or vinyl electrical tape.

- The black heating cable core is conductive and can short. It must be properly insulated and kept dry.
- Damaged bus wires can overheat or short. Do not break bus wire strands when scoring the jacket or core.
- Keep components and heating cable ends dry before and during installation.
- Bus wires will short if they contact each other. Keep bus wires separated.
- Use only fire-resistant insulation materials, such as fiberglass wrap or flame-retardant foam.

## Description

Cable description

Heating Cable	Type	Grommet
HTR	-CR or -CT	RED

WARNING: Use of the wrong grommet can result in leaks, cracked components, shock or dielectric failure, and will invalidate approvals and certifications

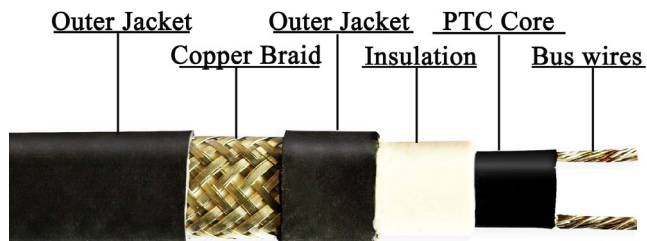

Structure of Model HTR-CR

### STEP 1

- Leave extra wire for connections and mishaps
- Middle of connection box (JHS-GET)



### STEP 2

Insert first the Pressure Seal End then the Grommet for each cable.



### STEP 3

- Do not cut the braiding
- Denude outer jacket
- Slightly bend the cable where you made the cut to denude it.



### STEP 4

- Do not cut the braiding
- At the bump, use a screwdriver to make a little hole in the braiding
- Bend the cable and make go through the braiding



**STEP 5**

- Make a pony tail with the braiding at the center of the cable



**STEP 6**

- Do not cut the bus wire
- Denude inner jacket
- Take the denude wire out

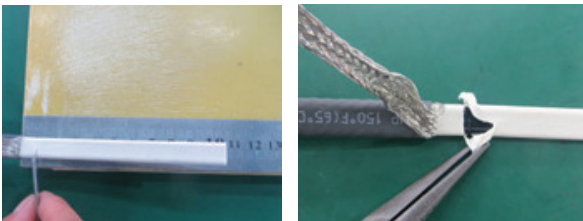

**STEP 7**

- Nick the denude area
- Pull back bus then denude section



**STEP 8**

- Cut the center area (core) between the two bus wires
- Bend and take the core out
- Take the core out of the bus wire
- Clean the two bus wires

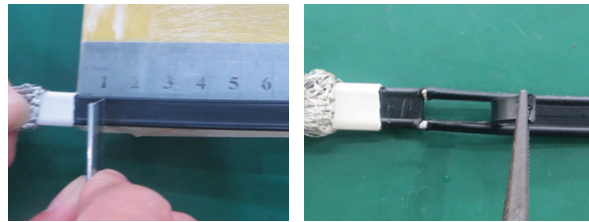

**STEP 9**

- Insert the two heating cables into the main box
- Install the 2 grommets into their positions
- Screw the two Pressure Seal Ends into the main box

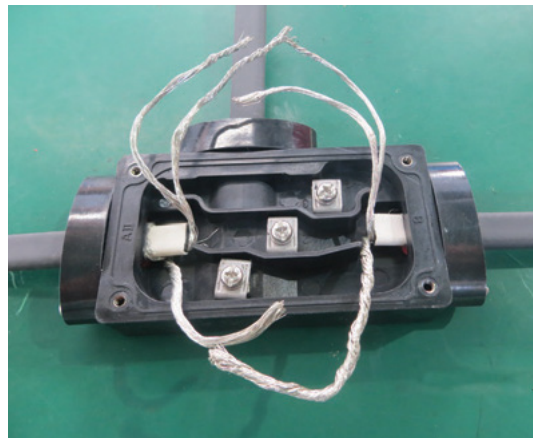

**STEP 10**

- Remove screws
- Install the wires in the main box
- Take out any loose or extra wire
- Take the wire away from the bus wire
- Tighten screws back into position

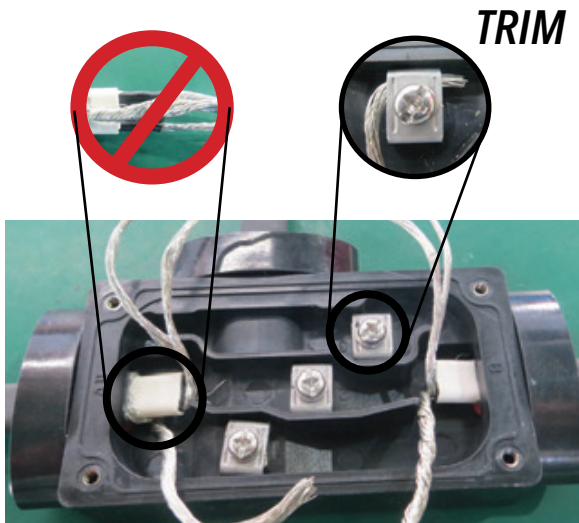

**STEP 12**

- Fix the low profile splice connection and side wires to the pipe
- Fix insulation
- Install label on the insulation protector
- Give instructions to the owner/user



**STEP 11**

- Install the gaskets and the covers onto the main box
- Tighten main cover with the four screws on the main box

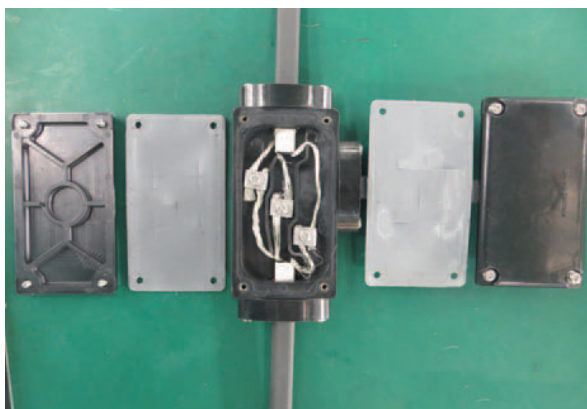

# PT-SPLICE-T-H (JHS-GET)

## INSTALLATION INSTRUCTIONS

### Description

The JHS-GET is design to be use with (HTR) parallel heating cables. The JHS-GET is installed on pipe under insulation and/or cladding. The JHS-GET is a (RATED NEMA TYPE 4X)

### Tools & Material Needed

- Wire cutter
- Nose Pliers
- Screwdriver
- Tie Wrap
- Glass Cloth Tape
- JSR03

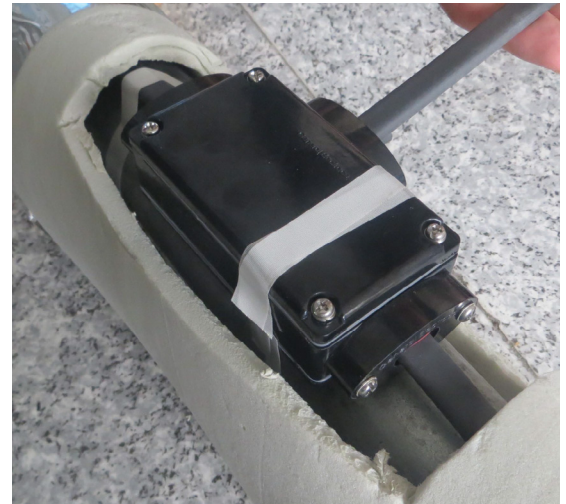

### Kit includes

Item	Qty	Description
A	1	Main Box
B	3	Pressure Seal End
C	3	Red Grommets
D	2	Gaskets for Main Box
E	2	Cover for Main Box
F	1	Label



C US

Class I, Div. 2, Groups A, B, C, D<sup>(2)</sup>  
 Class II, Div. 2, Groups E, F, G121  
 Class III<sup>(2)</sup>

### WARNING

This component is an electrical device that must be installed correctly to ensure proper operation and to prevent shock or fire. Read these important warnings and carefully follow all of the installation instructions.

- To minimize the danger of fire from sustained electrical arcing if the heating cable is damaged or improperly installed, and to comply with the requirements certifications, and National Electrical Codes, groundfault equipment protection must be used. Arcing may not be stopped by conventional circuit breakers.
- Component approvals and performance are based on the use of specified parts only. Do not use substitute parts or vinyl electrical tape.
- The black heating cable core is conductive and can short. It must be properly insulated and kept dry.
- Damaged bus wires can overheat or short. Do not break bus wire strands when scoring the jacket or core.
- Keep components and heating cable ends dry before and during installation.
- Bus wires will short if they contact each other. Keep bus wires separated.
- Use only fire-resistant insulation materials, such as fiberglass wrap or flame-retardant foam.

**Description**

Cable description PICTURE

Heating Cable	Type	Grommet
HTR	-CR or -CT	RED

WARNING: Use of the wrong grommet can result in leaks, cracked components, shock or dielectric failure, and will invalidate approvals and certifications

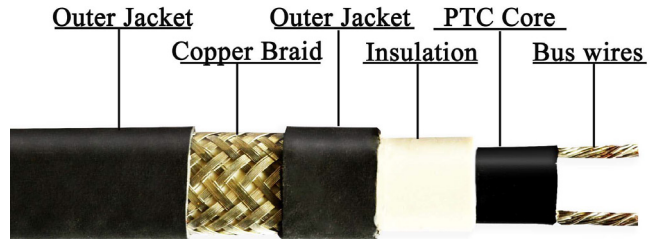

Structure of Model HTR-CR

**STEP 1**

- Leave extra wire for connections and mishaps
- Middle of connection box (JHS-GET)



**STEP 2**

Insert first the Pressure Seal End then the Grommet for each cable.



**STEP 3**

- Do not cut the braiding
- Denude outer jacket
- Slightly bend the cable where you made the cut to denude it.



**STEP 4**

- Do not cut the braiding
- At the bump, use a screwdriver to make a little hole in the braiding
- Bend the cable and make go through the braiding



**STEP 5**

- Make a pony tail with the braiding at the center of the cable

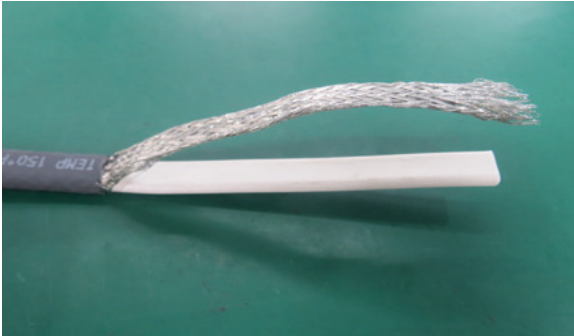

**STEP 6**

- Do not cut the bus wire
- Denude inner jacket
- Take the denude wire out

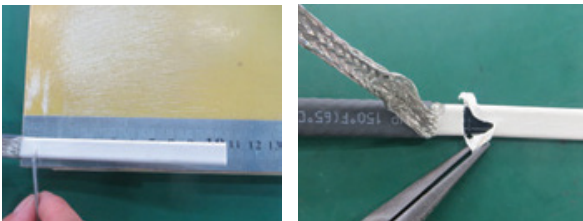

**STEP 7**

- Nick the denude area
- Pull back bus then denude section



**STEP 8**

- Cut the center area (core) between the two bus wires
- Bend and take the core out
- Take the core out of the bus wire
- Clean the two bus wires

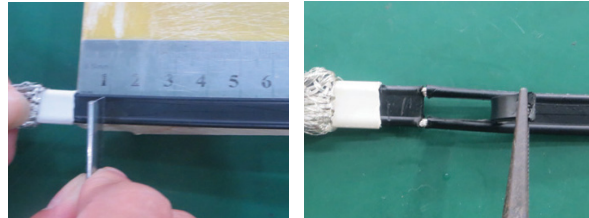

**STEP 9**

- Using the JSR03 glass cloth tape, put the ponytail braid against the inner jacket and do a minimum of 3 loops around the inner jacket.

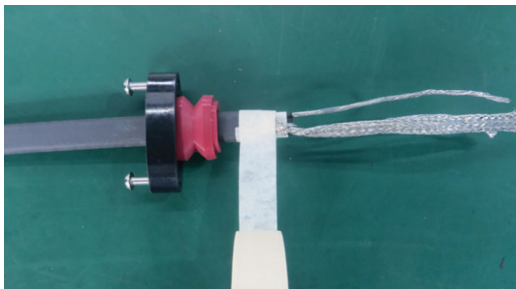

- Separate from the cable and loop a minimum of two times around the braid.

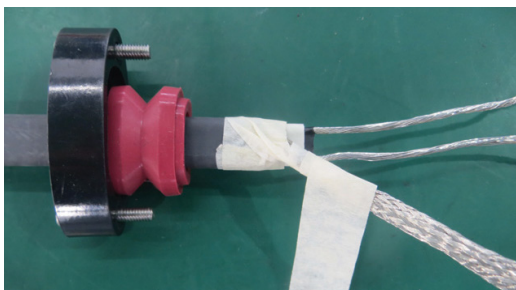

- Install the grommet to the edge of the loop tape. Do not install grommet over the tape.

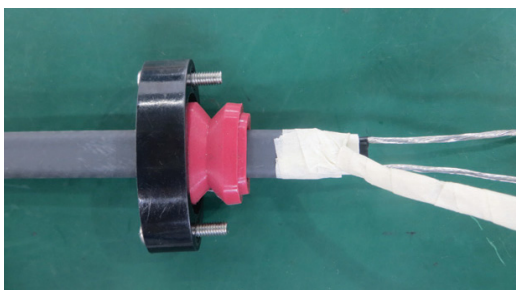

**STEP 10**

- Install T-Splice cable into the main box
- Install the grommet into the hole of the main box
- Push pressure seal end and then tighten screws back into the main box

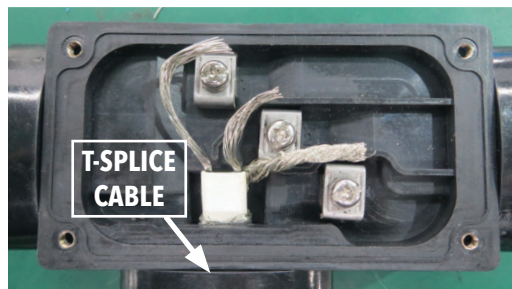

**STEP 11**

- Loosen the screws
- Install wires under contact bases
- Tighten the screws back into position
- Cut all extra wire and braid

**TRIM**



**STEP 12**

- Install the in-line cables into the main box
- Install the grommets into the holes of the main box
- Push pressure seal ends and then tighten screws back into the main box

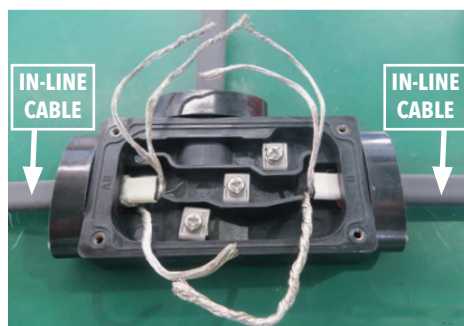



**STEP 13**

- Loosen the screws
- Install corresponding wires together under contact bases
- Tighten the screw back into position
- Cut all extra wire and braid

**TRIM**

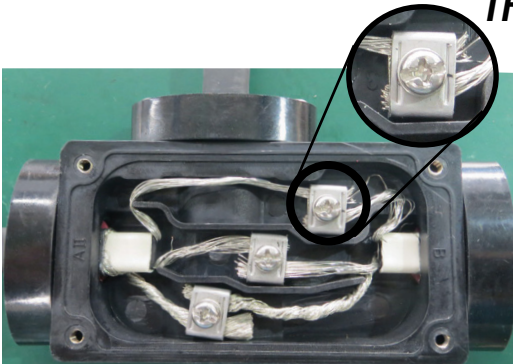

**STEP 14**

- Install the 2 gaskets and the 2 covers onto the main box.
- Tighten the screws back into position

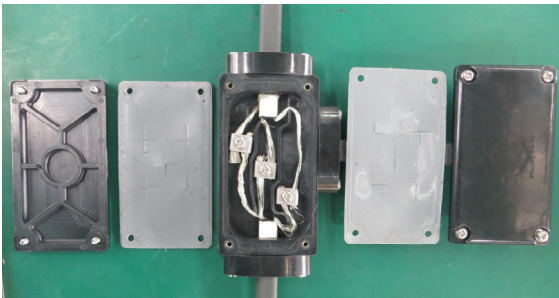

**STEP 15**

- Fix the Low Profile Tee Connection and side wires to the pipe using tape
- Fix insulation
- Install label on the of the insulation protector
- Give instruction to the owner user.

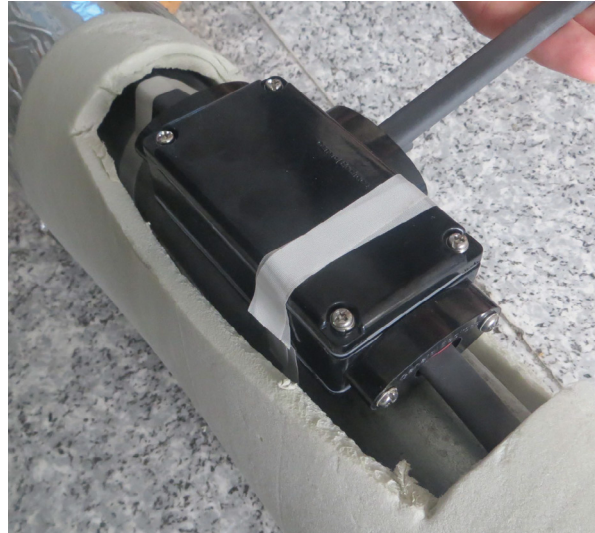

# PT-PWR-KIT-H (PTBO-GET)

## MULTIPLE-ENTRY OCTAGON POWER CONNECTION WITH JUNCTION BOX

### Description

Available for use in safe and hazardous areas  
 All boxes suitable for use with all styles of heating cable  
 NEMA 4X  
 Complete range of boxes & terminal



### Introduction

Standard, robust and corrosion resistant polyamide enclosures are supplied for use in safe (non-hazardous) or hazardous (Class1,Div.2) areas. When used in hazardous areas the enclosures provide type EExe protection (increased safety) in "Electrical Apparatus for Potentially Explosive Atmospheres".

### Specification

OPERATING TEMPERATURES	-40°C to +50°C (-40°F to +212°F)
EARTH CONTINUITY PLATE	Available as extra
APPROX VOLUME	38.7501in3 (635cm3 )
MATERIAL	Glass reinforced Polyester, Fire Retardant
SPECIAL FEATURE	The enclosure has a uniquely designed hinged cover that allows the unit to remain 'as one' during installation.

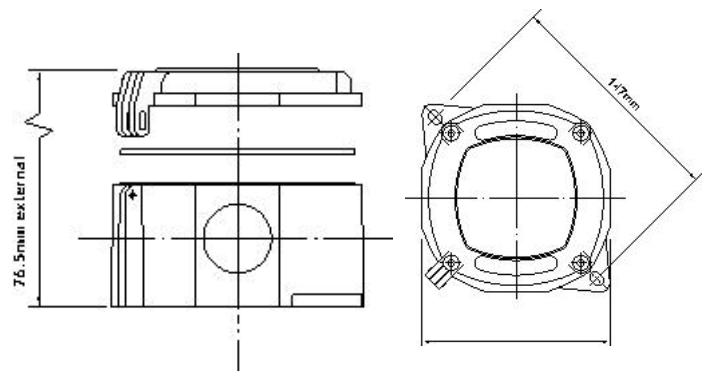
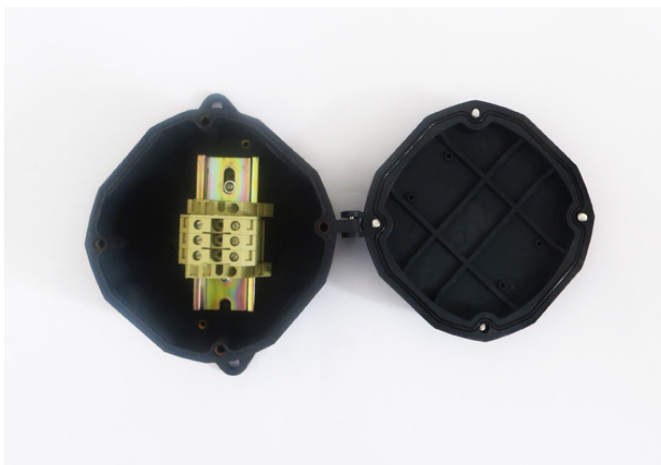

1. After the seal fitting is open, put the junction box cap, strain relief disk grommet, and body onto the power connection of cable.



Figure 1

2. Slice completely around heating cable outer jacket, and then down a distance of 4.5" (119mm), being careful not to cut braid or inner jacket. Then, bend heating cable to break jacket where sliced, and peel off outer jacket



Figure 2

3. Carefully push braid back to loosen and spread apart as shown.



Figure 3

4. The heating cable must be bent as shown in Figure 8 so it can be pushed through the braid opening.



Figure 4

5. Place braid to one side of cable. Cut inner jacket of cable back 3.5" (90mm).



Figure 5

6. Shave off outer matrix material from conductors with utility knife. See Figure 6.



Figure 6

7. Peel back exposed wires from central matrix material. See Figure 7. Do not cut bus wire strands!



Figure 7

8. Cut off remaining center core of matrix; leaving the bare conductors. Do not cut bus wires!

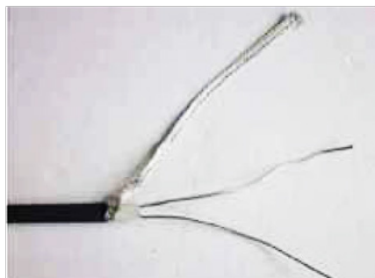

Figure 8

9. Slip on black shrink tubes 3" (77mm) in place up to conductive core.



Figure 9

10. Carefully shrink tubing by moving heat source from side to side continuously; being careful not to damage heating cable.



Figure 10

11. Then, insert green/yellow tube over braid and shrink.



Figure 11

12. Center black shrink tube 1" (25mm) over end of heating cable as shown in Figure 12.



Figure 12

13. While tube is still hot, pinch tube with pliers, between wires, and hold for 10 seconds to ensure seal. See Figures 13.



Figure 13

14. For heating cables with an outer jacket, slide parts in place as shown below.

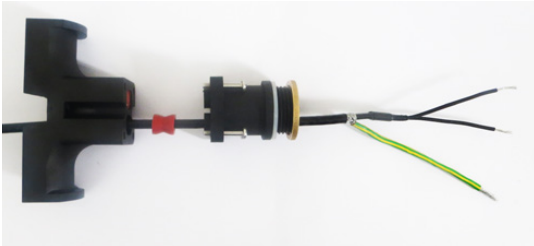

Figure 14-1



Figure 14-2

15. power wire: Cut inner jacket of cable back 3.9"(100mm)  
Cut Conductor wire 0.5"(12mm)



Figure 15

16. Connect the power conductors to the cable leads. Connect the incoming supply ground to the cable braid and to the green ground wire. The wire nuts, included, are not for use with aluminum feed wires. The junction box needs to be grounded.



Figure 16-1



Figure 16-2



Figure 16-3

## **WARRANTY INFORMATION**

*WarmlyYours agrees to repair or replace self-regulating heating cable which fails to function within TEN YEARS from the completed installation date if all of the following conditions have been met:*

- 1. Test of the self-regulating heating cable is performed according to the installation instructions relating to the specific application.*
- 2. Test results and the required information requested are sent in writing to WarmlyYours within 30 days of the completed self-regulating heating cable installation.*
- 3. The self-regulating heating cable is returned to WarmlyYours with proof of purchase and with a written explanation of the alleged defect(s) and/or is available for inspection by a WarmlyYours representative within 30 days of the discovery of the defect(s). No cables should be returned without prior authorization from WarmlyYours. For any self-regulating heating cable the consumer must prepay the shipment. The consumer is responsible for all costs involved in removing the self-regulating heating cable as well as all costs involved in reinstalling any repaired or replaced self-regulating heating cable. WarmlyYours is not liable for any incidental and/or consequential and/or business interruption losses or damages.*