

Installation Manual

BACKLIT MIRRORS

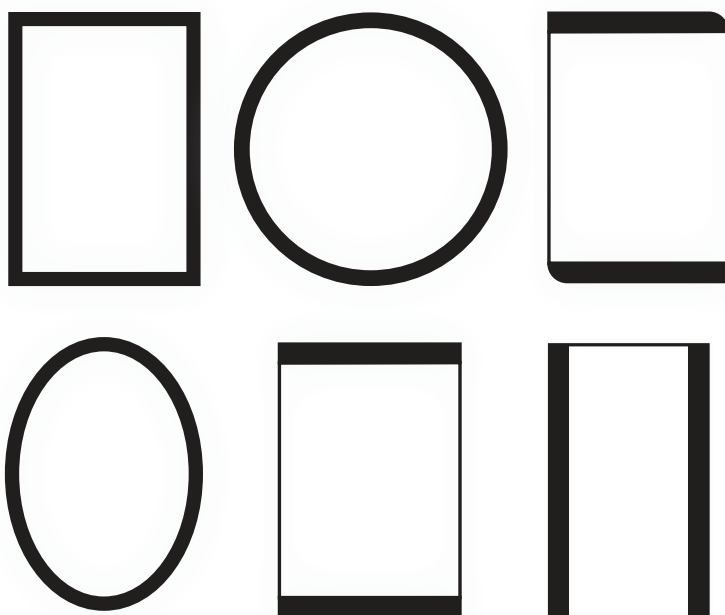

LUMIDESIGN

Personal Safety

Before installing light fixture, always remember to:

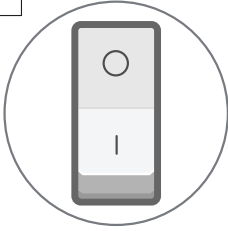

Turn off all power supply at the fuse or circuit breaker before installing light fixture

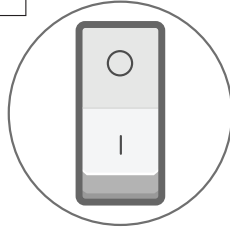

Turn off all power supply when performing any kind of maintenance on fixture

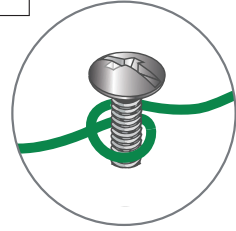

Ground fixture to avoid potential electric shock

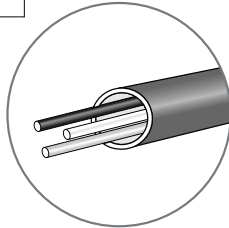

Double-check hard wire connections to ensure that they are installed correctly

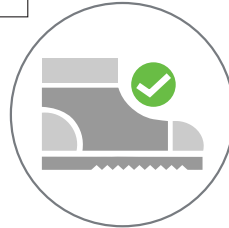

Wear proper safety footwear throughout installation process



ELECTRIC CURRENT THROUGH THE METAL HOUSING CAN CAUSE INJURIES AND EVEN POSSIBLE DEATH IF HANDLED IMPROPERLY.

Assembly Contents

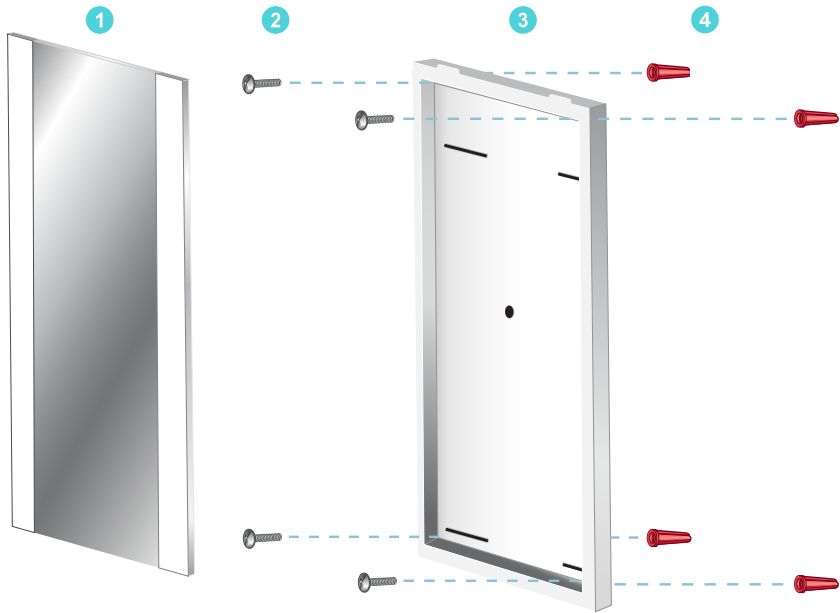

Legend/ Checklist

- 1. Mirror Glass
- 2. Fastening Screws
- 3. Metal Housing (Chassis)
- 4. Anchors

01 REROUTE POWER SUPPLY

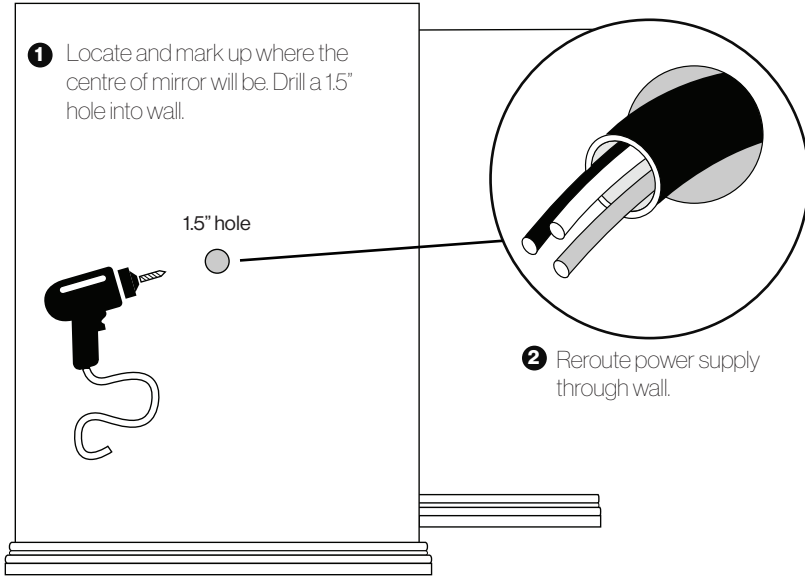

02 CONNECT POWER SUPPLY

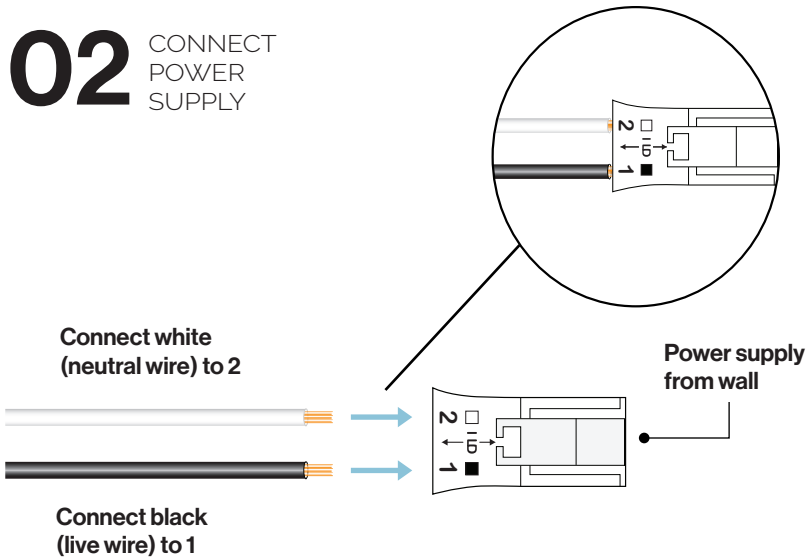

Take luminaires disconnect and connect it to power supply according to its corresponding colours.

03 FASTEN CHASSIS TO WALL

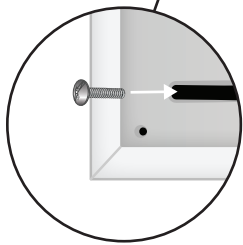
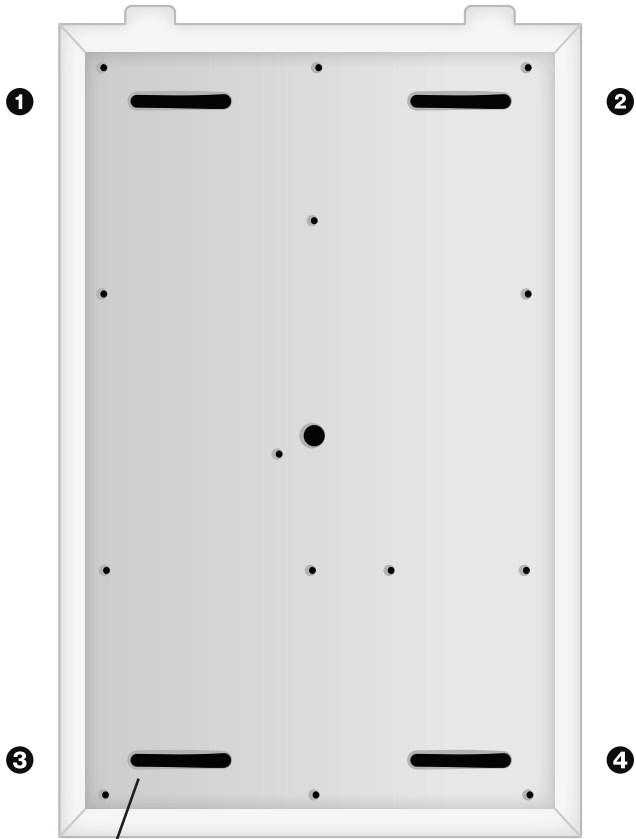

Fasten each corner with a screw

Place metal housing (chassis) against the wall. Select one screw knock-out, fasten chassis to wall with one screw and if needed an anchor. Repeat for each of the corners.

NOTE
SECURE FIXTURE TO AT LEAST ONE STUD.

04 CONNECT GROUND WIRE

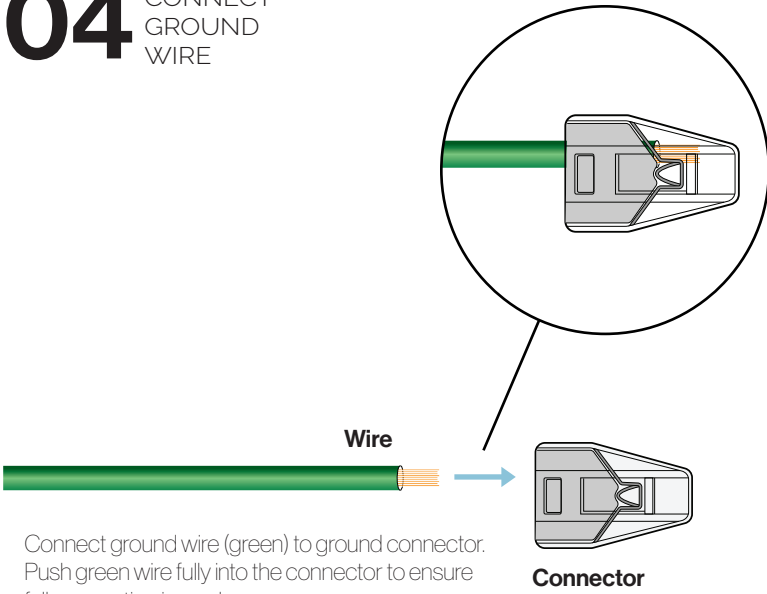

Connect ground wire (green) to ground connector. Push green wire fully into the connector to ensure full connection is made.

05 CONNECT LUMINAIRE DISCONNECTS

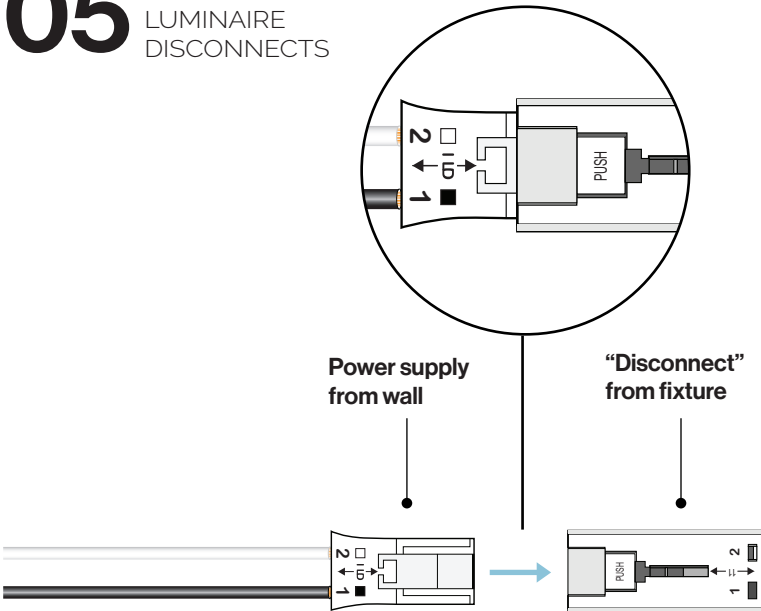

Connect luminaire disconnects by pushing them firmly together.

06 TEST LED LIGHTS

- 1 Turn on wall switch to test lighting. All lamps should turn on without flickering.



If flickering occurs, refer to troubleshooting guide or contact a lighting engineer.

- 2 Turn off lamps when finished with testing.

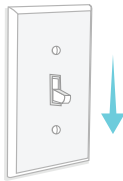

07 HANG MIRROR TO TABS

To install mirrored glass piece, carefully lift the mirror, align mirror hanger with tabs and hang mirror onto chassis.

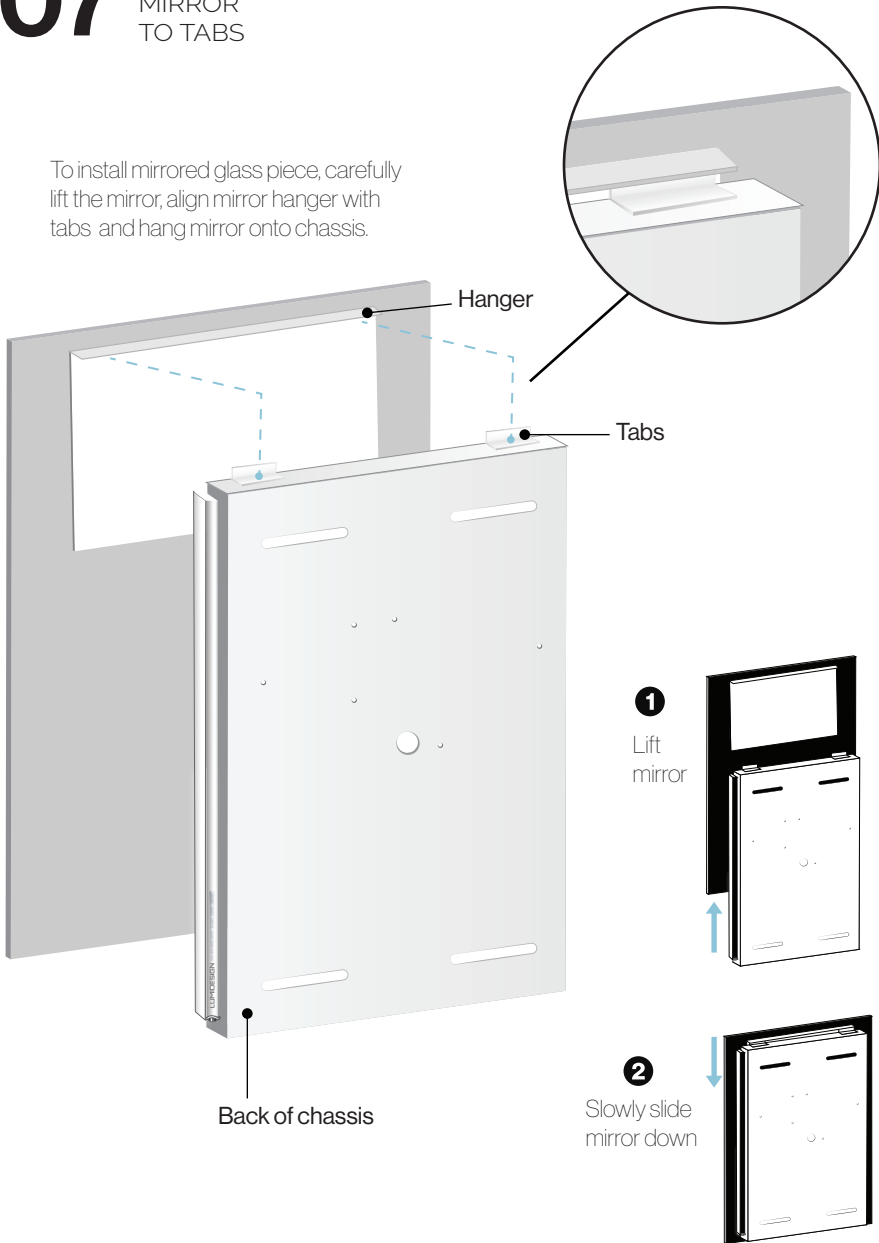

Ensure mirror is securely and properly installed. Test this by gently pulling mirror towards you, if mirror can be lifted, redo Step 7. If mirrors are not hung on properly, accidents may occur and may cause serious injuries and even deaths!

Finished.

For technical support and other inquiries, contact Lumidesign:

E info@lumidesign.ca

☎ 905 597 5988

Manuel D'instillation

MIROIRS ÉCLAIRÉ

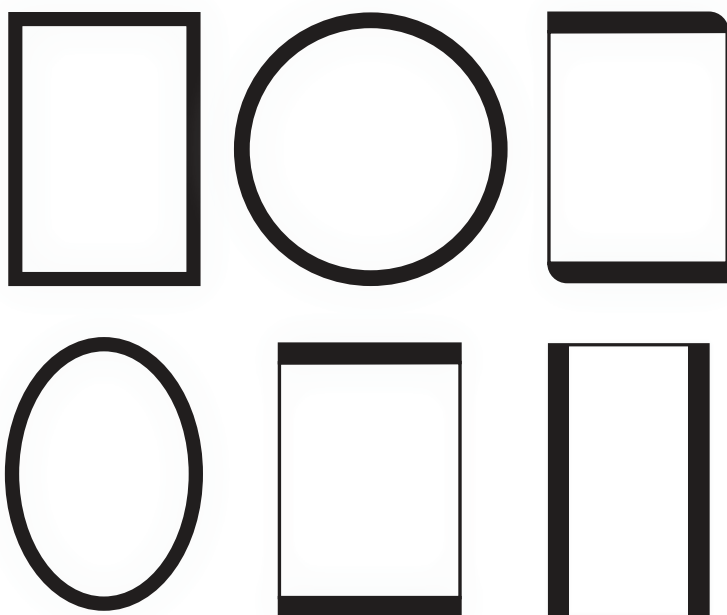

LUMIDESIGN

Sécurité Personnelle

Avant d'installer l'appareil d'éclairage, ne oubliez pas de:

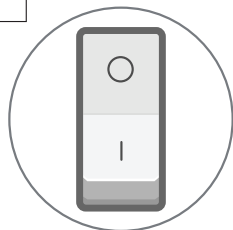

Coupez l'alimentation électrique au fusible ou un disjoncteur avant d'installer luminaire

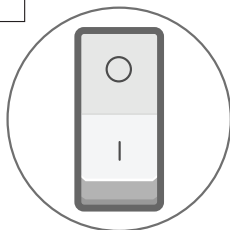

Coupez l'alimentation électrique lorsque vous effectuez tout type de maintenance sur luminaire

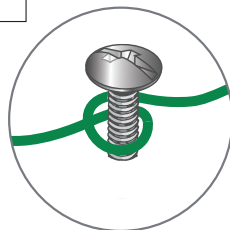

Rez luminaire pour éviter les chocs électriques potentiels

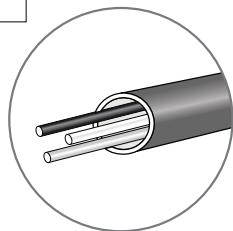

Double-vérification des connexions de fil dur pour se assurer qu'ils sont correctement installés



Porter des chaussures de sécurité approprié quand au long du processus d'installation



LE COURANT ÉLECTRIQUE À TRAVERS LE BOÎTIER DE MÉTAL PEUT CAUSER DES BLESSURES ET MÊME LA MORT POSSIBLE SI MANIPULÉ CORRECTEMENT.

Liste de Contenu

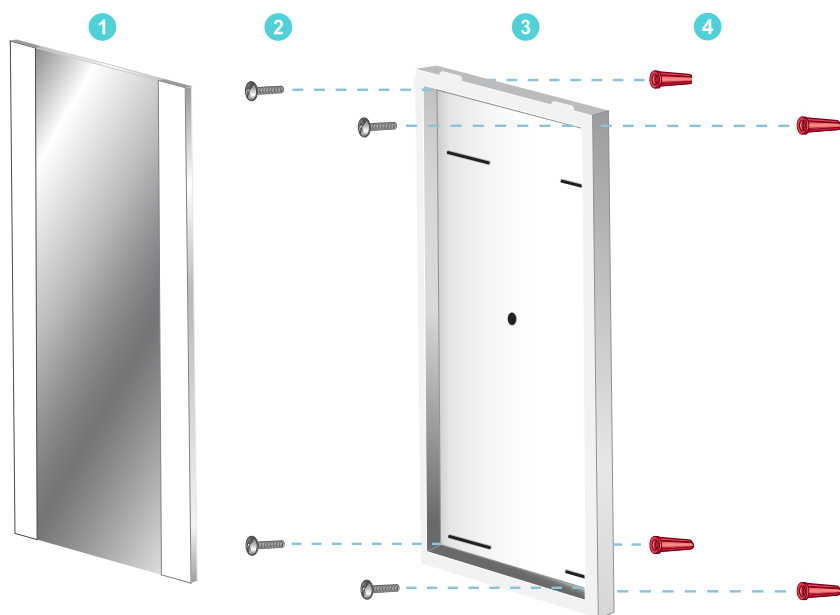

Liste de contrôle

- 1. Miroir avec Crochets
- 2. Vis de fixation
- 3. Boîtier Métallique
- 4. Prise Murale

01 RÉ-ACHEMINÉ À TRAVERS L'OUVERTURE

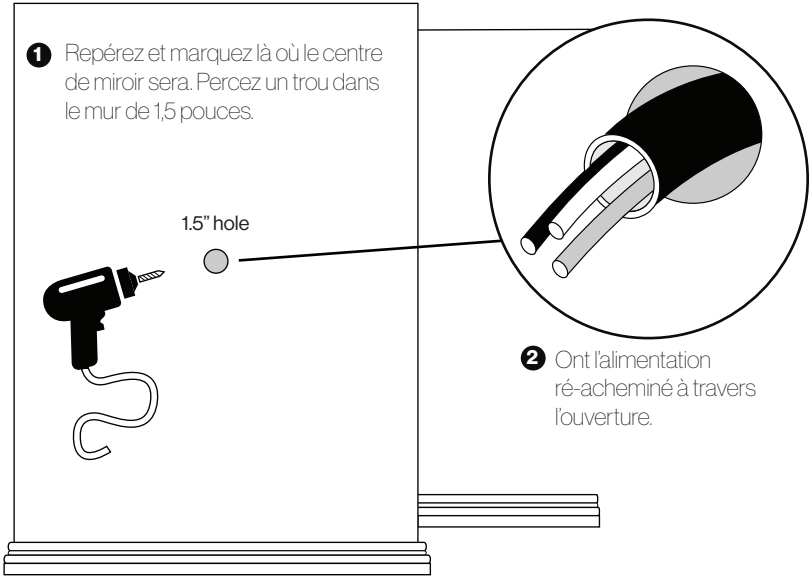

02 LE CONNECTER L'ALIMENTATION

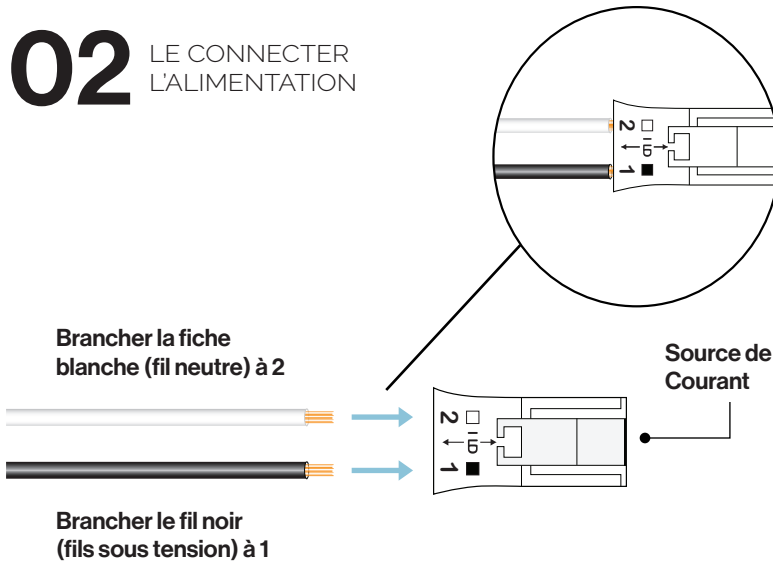

Prendre la déconnexion du luminaire et le connecter à l'alimentation en fonction de ses couleurs correspondantes.

03

FIXEZ LE
CHÂSSIS
AU MUR

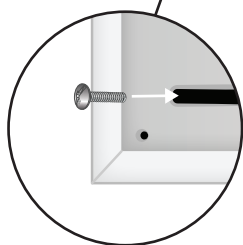
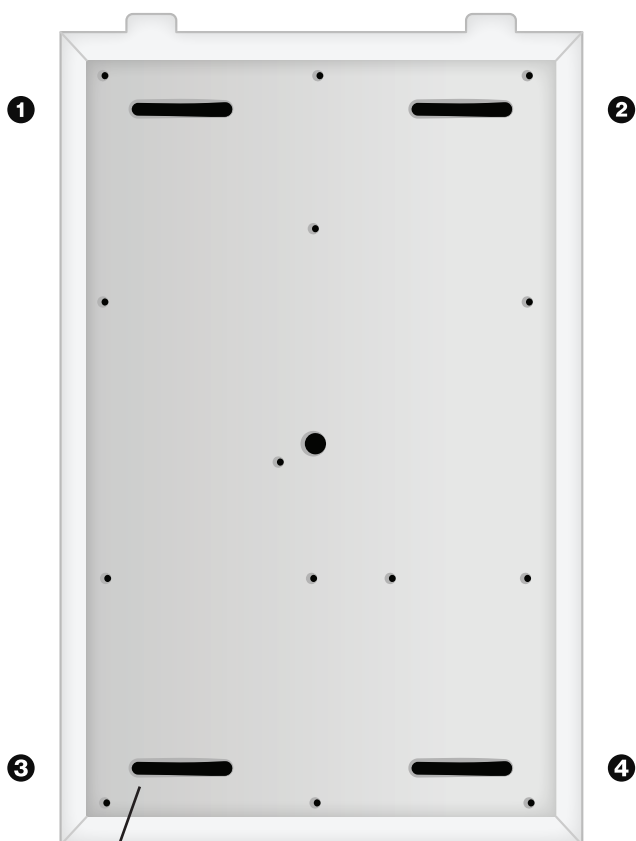

Fixez le châssis au mur avec une vis.

Placez boîtier métallique (châssis) contre le mur. Sélectionnez un trou de vis, fixer le châssis au mur avec une vis et si nécessaire une prise murale. Répéter l'opération pour chacun des coins.

04

CONNECTEZ
LE FIL DE MASSE AU
CONNECTEUR DE TERRE

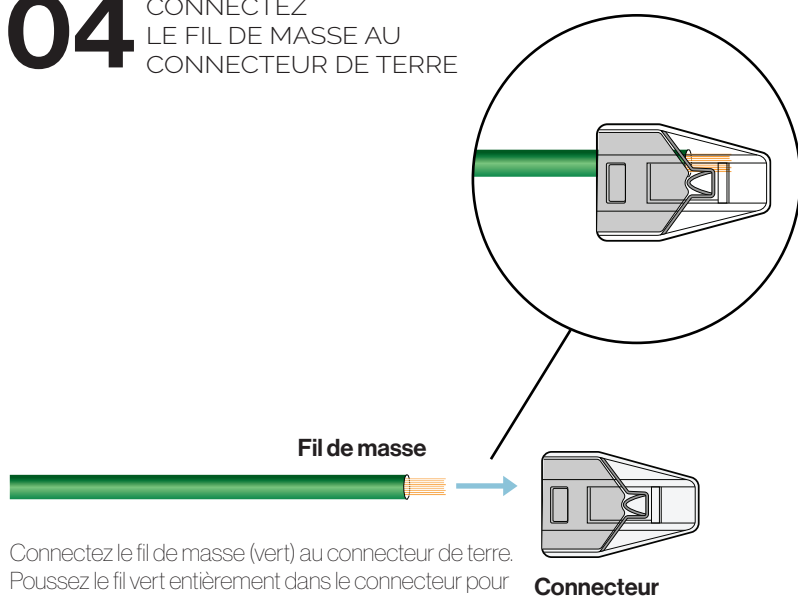

Connectez le fil de masse (vert) au connecteur de terre. Poussez le fil vert entièrement dans le connecteur pour assurer la pleine connexion est établie.

05

CONNECTER
LES DÉCONNECTEURS
LUMINAIRE

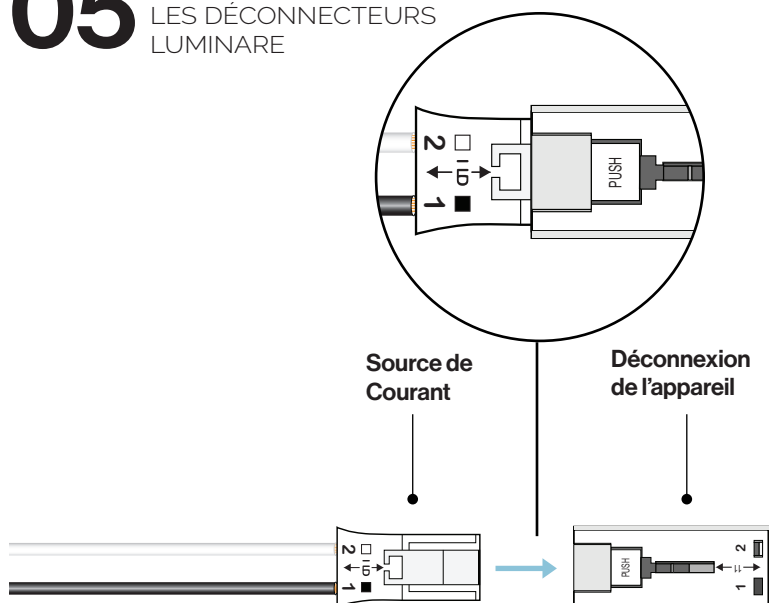

Appuyez fermement les déconnecteurs Luminaire ensemble.

06 TESTER L'ÉCLAIRAGE

- 1 Allumez l'interrupteur mural pour tester l'éclairage. Toutes les lampes doivent tourner sans scintillement.

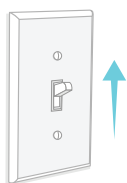

Si le scintillement se produit, reportez-vous au guide de dépannage ou contactez un ingénieur d'éclairage.

- 2 Éteindre les lampes lorsque vous avez terminé avec les tests.

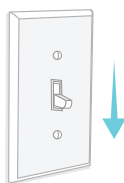

07 INSTALLER LE MIROIR

Pour installer le miroir, soulevez docement le miroir, aligner les cintres avec des onglets et l'accrocher sur le chassis.

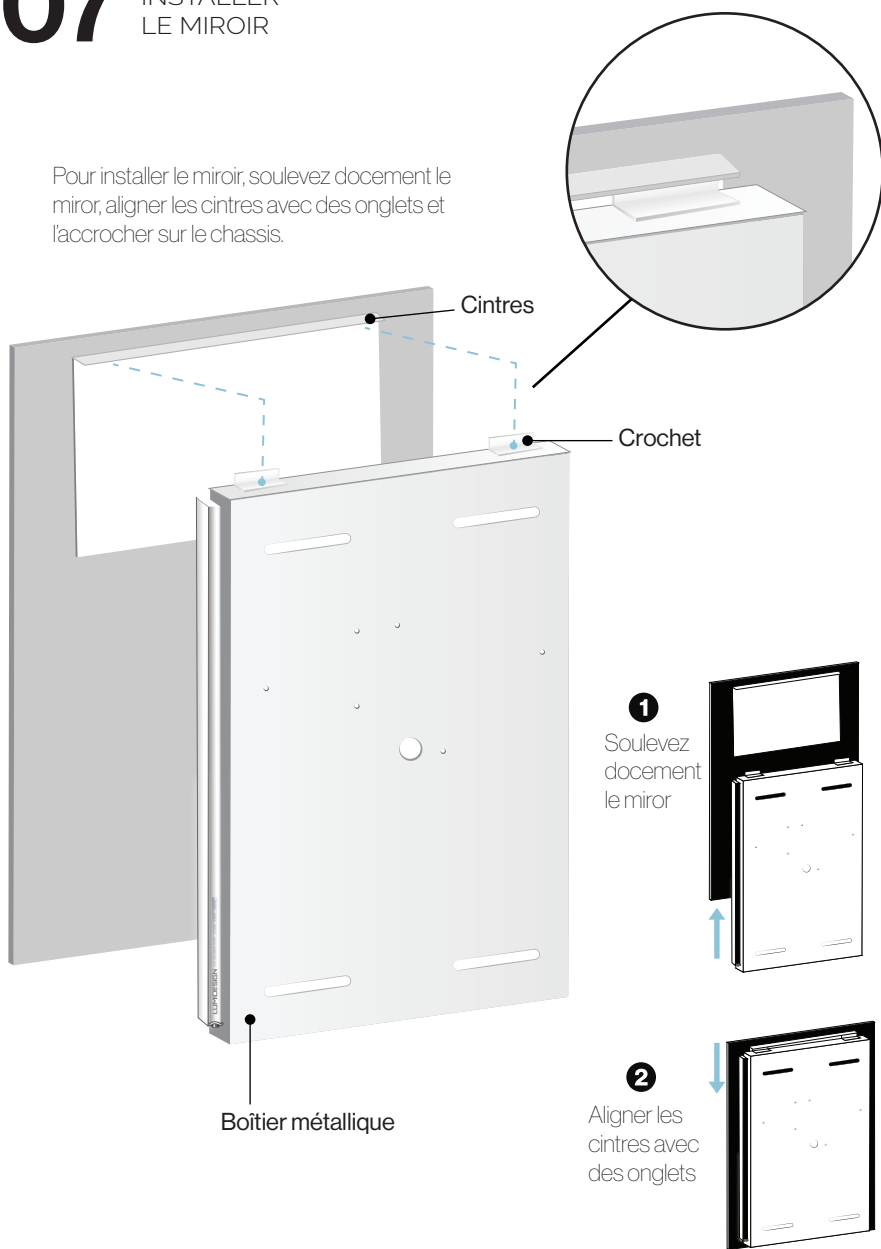

Assurer le miroir est solidement et correctement installé. Tester cela en tirant doucement le miroir vers vous, si le miroir peut être levée, refaire l'étape. Si les miroirs ne sont pas accroche correctement, il peut se produire des accidents causant des blessures graves et meme la mort!

Fini.

Pour le support technique et d'autres renseignements, contacter Lumidesign:

E info@lumidesign.ca

☎ 905 597 5988