

## Features

- Low-threshold design for easy entry and exit.
- Molded-in textured floor.
- Water containment bead incorporated into the threshold design provides an optimum barrier, eliminating water escaping from the shower space.
- Single threshold for alcove installation.
- Durable acrylic construction.
- Center drain.
- Coordinates with Choreograph® shower walls and other KOHLER collections.



## Recommended Products/Accessories

K-9132 Shower Drain

## Codes/Standards







CSA B45.5/IAPMO Z124  
ASTM E162  
ASTM E662

## KOHLER® Plastic Baths and Receptors Lifetime Limited Warranty

See website for detailed warranty information.

## Available Colors/Finishes

*Color tiles intended for reference only.*

Color	Code	Description
	0	White
	96	Biscuit
	47	Almond
	NY	Dune
	95	Ice™ Grey
	G9	Sandbar

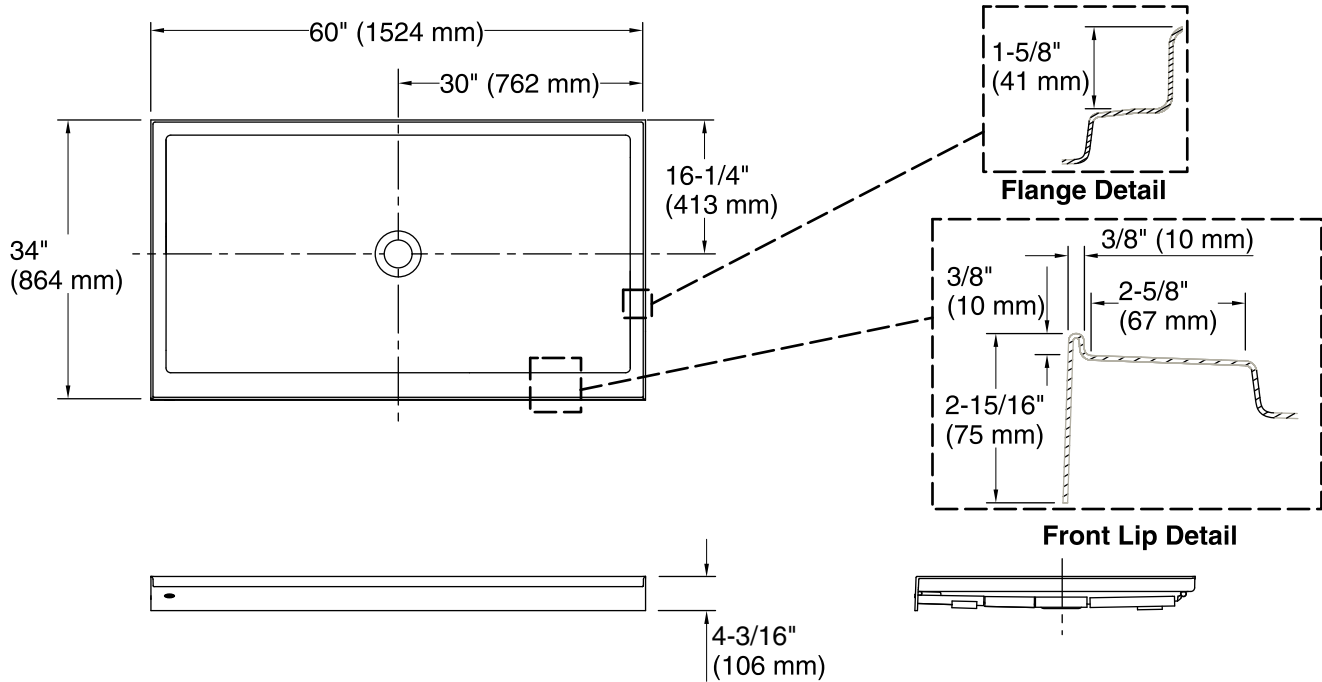

## Technical Information

All product dimensions are nominal.

Installation: Three-wall alcove  
 Drain location: Center  
 Weight: 63 lbs (28.6 kg)

## Notes

Measure your actual product for rough-in details. Install this product according to the installation instructions. Subfloor must be within 1/2" (13 mm) of level. This receptor has a front lip. This should be taken into account when installing a shower door.