

Features

- Brass construction.
- Compression valves.
- Pair of angle supplies with stop.
- Annealed vertical tube with union connection.
- 3/8" NPT connection with flange.
- Four-arm handle stop.



Codes/Standards

ASME A112.18.1/CSA B125.1

NSF/ANSI 61

NSF/ANSI 372











All applicable US Federal and State material regulations

KOHLER® One-Year Limited Warranty

See website for detailed warranty information.

Available Colors/Finishes

Color tiles intended for reference only.

| Color | Code | Description |
|--|------|--------------------------|
|  | CP | Polished Chrome |
|  | SN | Vibrant® Polished Nickel |
|  | AF | Vibrant® French Gold |
|  | PB | Vibrant® Polished Brass |
|  | G | Brushed Chrome |
|  | BN | Vibrant® Brushed Nickel |
|  | BV | Vibrant® Brushed Bronze |
|  | BKB | Brushed Black |
|  | KB | Black Iron |
|  | AU | Polished Gold |

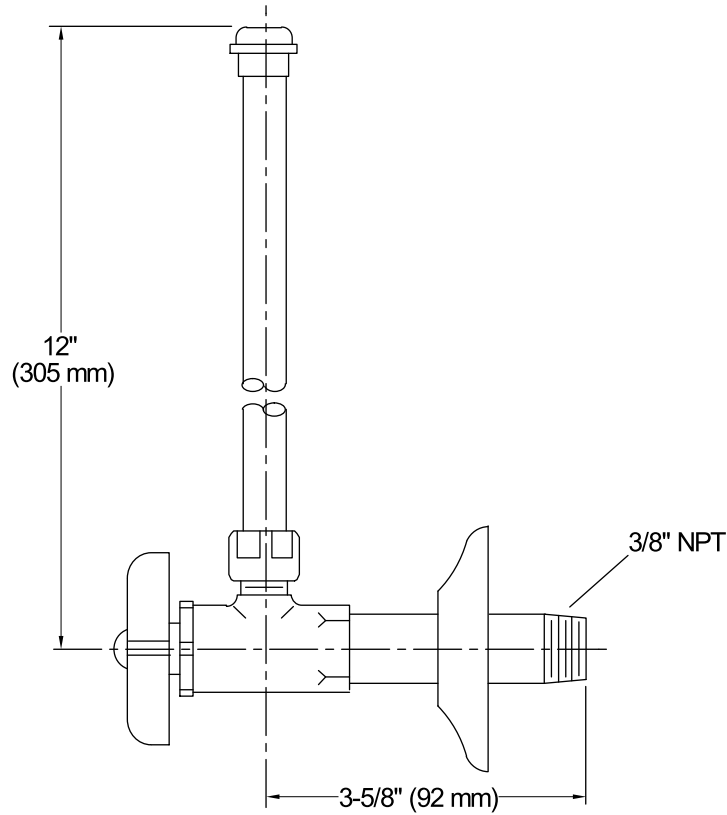

Technical Information

All product dimensions are nominal.

Notes

Install this product according to the installation guide.