

Features

- Frameless design emphasizes glass and creates a sleek, minimalist look.
- Full-length magnetic seal keeps door firmly closed, providing excellent water containment.
- Continuous 7/8" (22 mm) high aluminum bottom threshold.
- Back-to-back 11-1/2" (293 mm) vertical shower door pulls.
- Coordinates with other products in the Composed® collection.

Material

- Frameless, 3/8" (10 mm) thick Crystal Clear tempered glass.
- Anodized aluminum hardware prevents rusting or corrosion.

Technology

- CleanCoat® nanotechnology provides a smooth, nonstick surface to help prevent buildup of water stains, bacteria and mildew on your glass, to make it easy to clean and keep it looking like new.

Installation

- Fits opening widths 39-5/8"–40-3/8" (1006–1026 mm).
- 3/4" (19 mm) width adjustment.
- 3/8" (10 mm) out-of-plumb adjustability per side allows for simpler installation.
- Door can be installed to open to the left or right to suit your bathroom layout.
- For residential use only.
- Not for use in hospitality.

Included Components

Additional Components:
Hardware kit

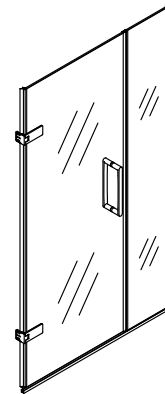

Codes/Standards



ANSI Z97.1
CPSC 16CFR 1201

KOHLER® One-Year Limited Warranty

See website for detailed warranty information.

Available Colors/Finishes

Color tiles intended for reference only.

Color	Code	Description
	SHP	Bright Polished Silver
	BL	
	BNK	Anodized Brushed Nickel

Available Glass Options

Code	Description
L	Crystal Clear

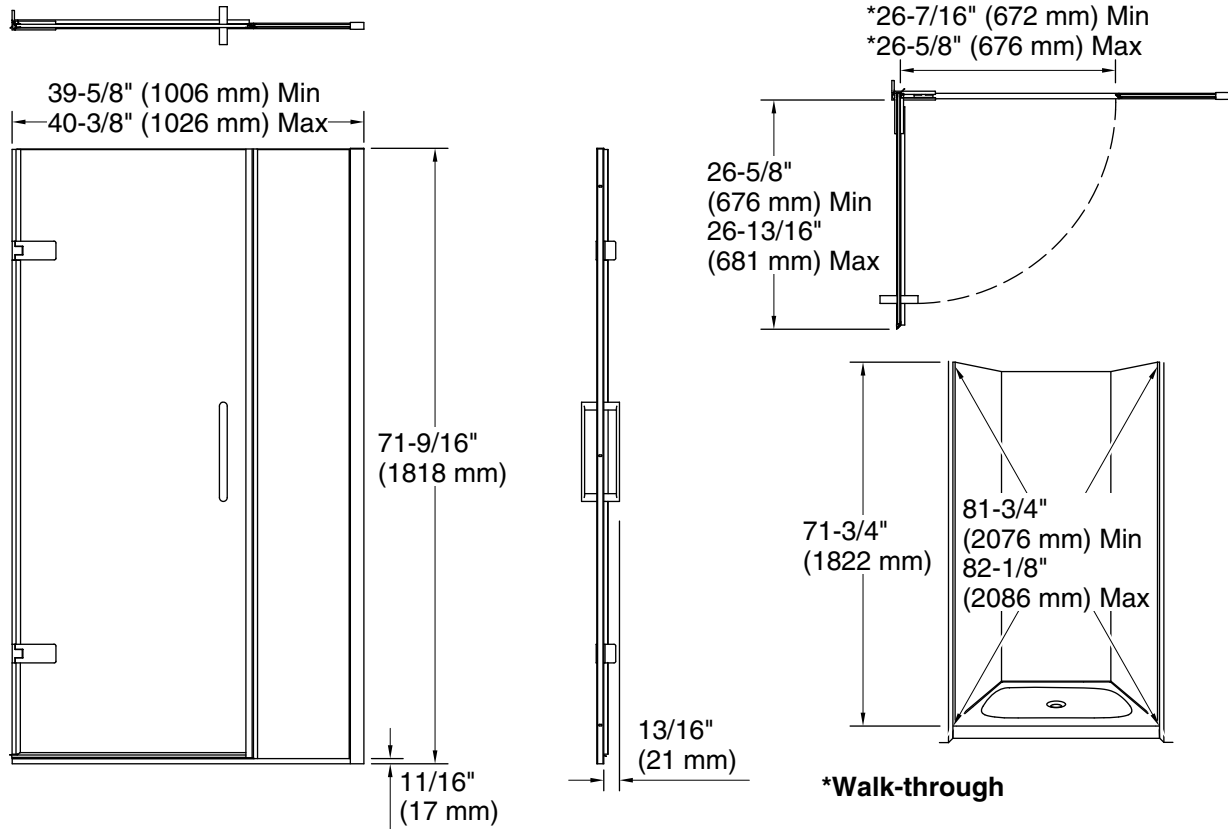

Technical Information

All product dimensions are nominal.

Installation type: For shower base installation

Opening Width - Min: 39-5/8" (1006 mm)

Opening Width - Max: 40-3/8" (1026 mm)

Walk-through - Min: 26-3/8" (670 mm)

Walk-through - Max: 26-5/8" (676 mm)

Base-To-Wall Radius 1/4" (6 mm)

– Max:

Glass thickness: 3/8" (10 mm)

Glass coating: CleanCoat®

Notes

Install this product according to the installation instructions.

The vertical opening should be a minimum of 73-1/2" (1867 mm) to allow for installation clearance.