

Installation manual for: 2092W7C/RC

Dimensions : W7" E3.5" H12" L2
Collection : Influx
Bulb Type : G9 bulb, not include bulb
Lamp Frame Weight : 2.56 LBS
Total Weight : 3 LBS



Thank you for choosing our exquisite products. We are providing the finest quality crystal chandelier for our customers. Our master designers and craftsmen intend to give a professional insight on lighting design and product quality. Prompt and efficient services are our priority. We enclosed detailed instructions on how to install your light fixture properly. Please read all instructions carefully and thoroughly. If you have any questions, our professional customer service team is committed to assisting you, please call our toll free HOTLINE AT:

1-888-388-3390



UL
c
US



SAFETY

Warning: MAKE SURE THE ELECTRICITY TO THE WIRES YOU ARE

WORKING ON IS SHUT OFF BY EITHER REMOVING THE FUSE OR TURNING OFF THE CIRCUIT BREAKER.

CAUTION

- Before assembling the lighting fixture, please read all instructions carefully.
- All frame & crystal components are fragile, please handle with care.
- Required supply circuit : 110 - 130V/60Hz
- Labeled wires are "L" for live wire, "N" for neutral wire, "E" for GND.
- Never install fixture on damp ceiling, the room should be dry and well ventilated.
- All electrical components must be installed by a licensed electrician and in accordance with the National Electrical Code and the appropriate local electrical codes.

Unpack the Package

Please open the box carefully and check all the items are inside the box. If you have any installation, assembling and missing parts questions, please call our Customer Service department at 1-888-388-3390. Please have model number(at the front page), where you purchase from and any other relevant information ready, our customer service team will provide comprehensive and worry free service to our valued customers.

Returns and Conditions of Warranty

Returns must be pre-authorized by contacting our customer service department at the address on the reverse side. Returns will only be accepted with a written return merchandise authorization and return shipping charges pre-paid. We reserve the right to inspect all returned merchandise to fully determine the nature of any defect. This guarantee shall not apply to any product that has been changed, altered or otherwise modified, nor shall it apply to any product that has been repaired or altered by anyone other than a pre-authorized facility. We will not be responsible for any breakage or damages incurred during transit, nor for crystal parts or metal frame part that have been subject to misuse, negligence, accident or inappropriate handling. Also, we will not be held responsible for damage incurred during improper installation or wiring by others, nor for damages resulting from a failure to follow the recommended maintenance or installation procedures. This guarantee is issued in lieu of any and all other guaranteed or warrantee, whether written or implied and any and all other obligations or liabilities. Further, we neither authorize nor permit any other person or firm to assume for us, any liability in connection with the sale of our products.

Elegant Lighting Warranty

The finish and frame of your new chandelier or fixture are warranted for a period of two (2) years from the date of purchase. Our company will, at its option, repair or replace any frame that has a defect in the materials or workmanship during the warranty period. All crystals are guaranteed for their original quality during the life of the chandelier. Breakage is not covered by this warranty.

To make a claim under this warranty, contact our customer service department at the address and phone number shown below. A written return authorization form will be sent to you with specific instructions.













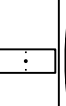

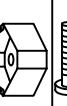
CUSTOMER SERVICE DEPARTMENT
500-550 E. Erie Avenue
Philadelphia, PA 19134
Tel : 215-423-8880
Fax : 215-423-8882

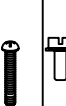
03



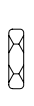
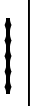



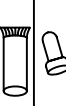

Step 1

Please use the parts list to ensure you are not missing any parts.

2092W7

part	picture	Description	Qty	Check list
ZA		GND	1	
ZB		Junction Caps	1	
ZC(P01)		Mounting bracket(φ4")	1	
ZD(P13)		Canopy (L11.8"*W4.7", Chrome)	1	
ZE(P04)		Knurled nut	2	
ZF		Mounting bracket screws	2	
ZG		Electrical box(not include)	1	
P01		Mounting bracket(φ4")	1	
P02		Ground screw	1	
P03		Mounting bracket screw (L1.4")	1	
P04		Knurled nut	2	
P05		M10 Rubber gasket	4	
P06		M10 Nipple	3	
P07		M10 Hex nut	3	
P08		M10 Lock washer	2	
P09		GND	1	
P10		Cable tie	2	
P11		Junction caps	2	
P12		Heat shrink tubing	2	
P13		Canopy (L11.8"*W4.7", Chrome)	1	

04

Part	Picture	Description	Qty	Check list
P14		M4 Phillip flange bolt	2	
P15		Aluminum tube shade	1	
P16		Hitch pin clip	10	
P17		Coupling	1	
P18		Socket cover (ø0.9*H1.65", Chrome, Iron)	2	
P19		G9 Socket	2	
P20		G9 Bulb	2	
A		1050-14#*15	10	

Frame Assembly Diagram

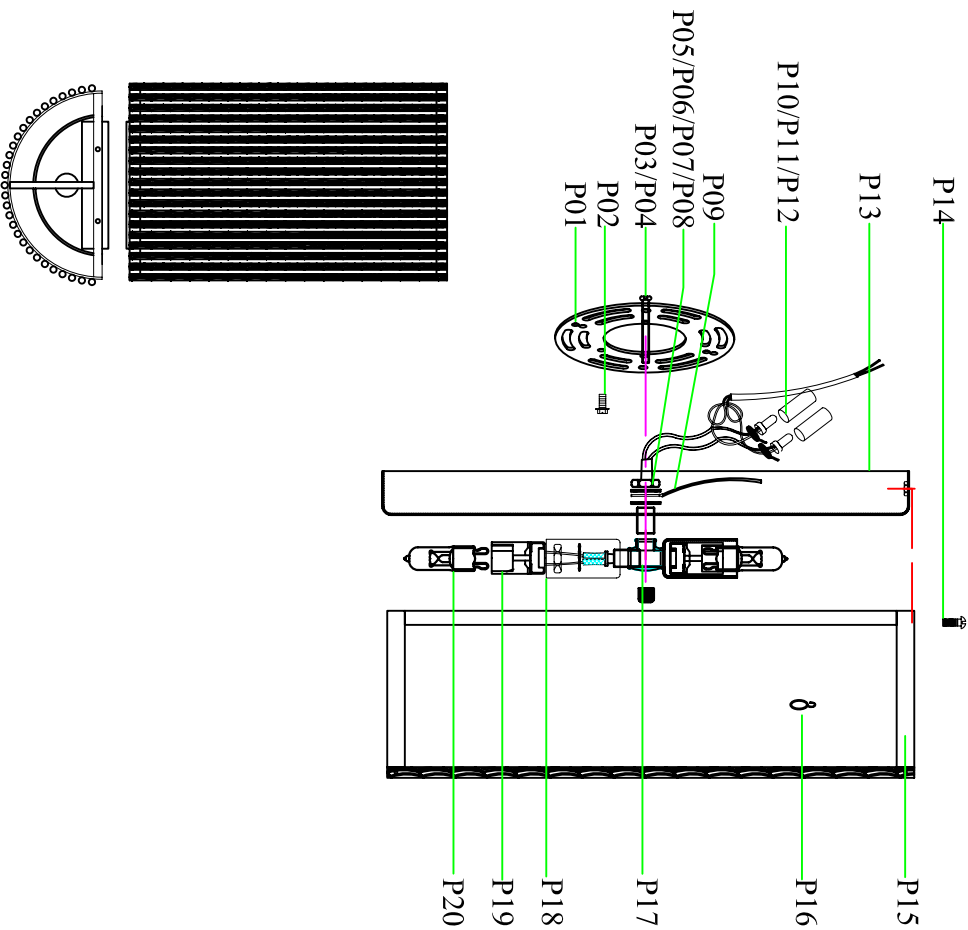

Cleaning and Maintenance of Chandelier Frame

The finish on our chandelier frames and fixture frames is protected by a durable coating of lacquer. To clean, use a clean soft, dry cloth. Do not use any metal polishes, cleaners, abrasives or any substance which could remove the protective finish.

Failure to follow these instructions automatically voids the guarantee.

Cleaning and Maintenance of Crystals

Wet a soft cotton fabric in clean warm water and wipe gently, then polish with a dry soft cotton fabric.

To Order Crystal Replacement Parts

Should you require replacement crystals or pins (the metal connectors attaching the crystals), contact the store where the product was purchased or contact us at the address shown on the reverse side. For ease of ordering, you may use the original crystal trimming instructions provided with this product and circle the items you wish to order, indicating the quantity by writing the number needed adjacent to the circle and faxing it to our customer service department at 215-423-8882. You will be contacted with prices prior to shipment. All orders must be pre-paid.

07

Step 2

IMPORTANT: Test sockets with bulb before dressing the fixture.

1. Attach the Mounting bracket(ZC) to the electrical box.
2. Pull wires up through the Junction Caps(ZB).
3. Attach the Canopy(ZD) to the Wall panel.
4. Make the electrical connections as detailed in the drawing above.

Canopy Installation Instruction

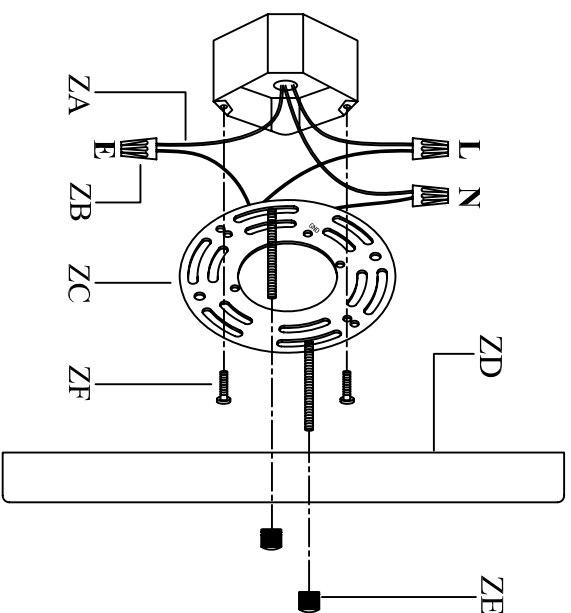

"L" = Hot wire
 "N" = Neutral wire
 "E" = GND

08

Step 3

Frame Assembly Instructions

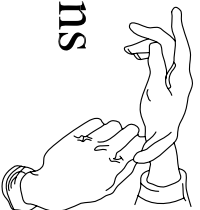

Installation:
Please read all instructions carefully.

Before you proceed to install, make sure that the power supply is turned off and remains off until installation is complete.

Please note that each part has been assigned a number. Please proceed in a numerical order.

1. Use Knurled nut(01) to fasten Canopy(02) on Mounting bracket with Wall panel.

2. Install G9 Bulb(03).

The end!

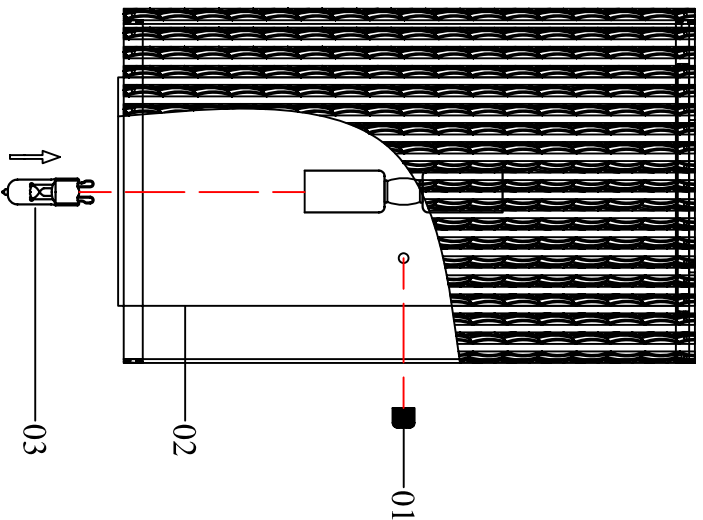

09

Congratulations !

You are now done installing your Elegant Lighting fixture.

Sit back and admire each crystal as it will become the statement piece for your room/house.

If you require any additional assistance, please contact us at 1-888-388-3390.

Thank you.

Step 4

Crystal Dressing Diagram



When dressing the chandelier with the crystals please remember to wear either rubber or cotton gloves. So as to prevent any damage or smudging on the crystals.

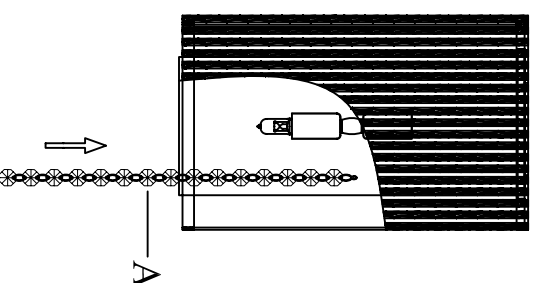

10

Hang the crystal (A).